

# Cleaning Tool

for Primado2 Attachments



**Primado2**

## Efficient cleaning of contaminants in the lumen

Reduce the risk of excessive heat development and malfunction of attachments due to insufficient cleaning



Contaminants in the lumen

## Specially designed Cleaning Holder

Maintains balance of flow rate in each outlet

Comparison table of flow rate\*

- Controlled Design
- Uncontrolled Design

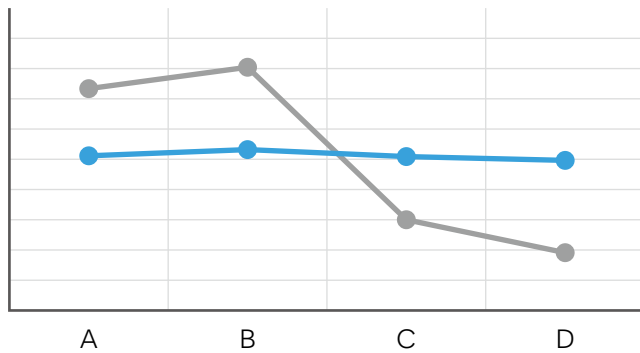

\*Based on the result of in-house testing

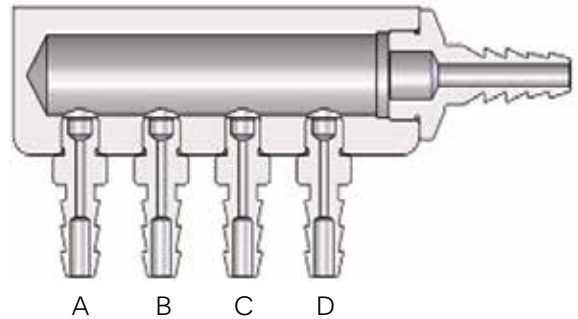

## Choice of cleaning options

Manual cleaning









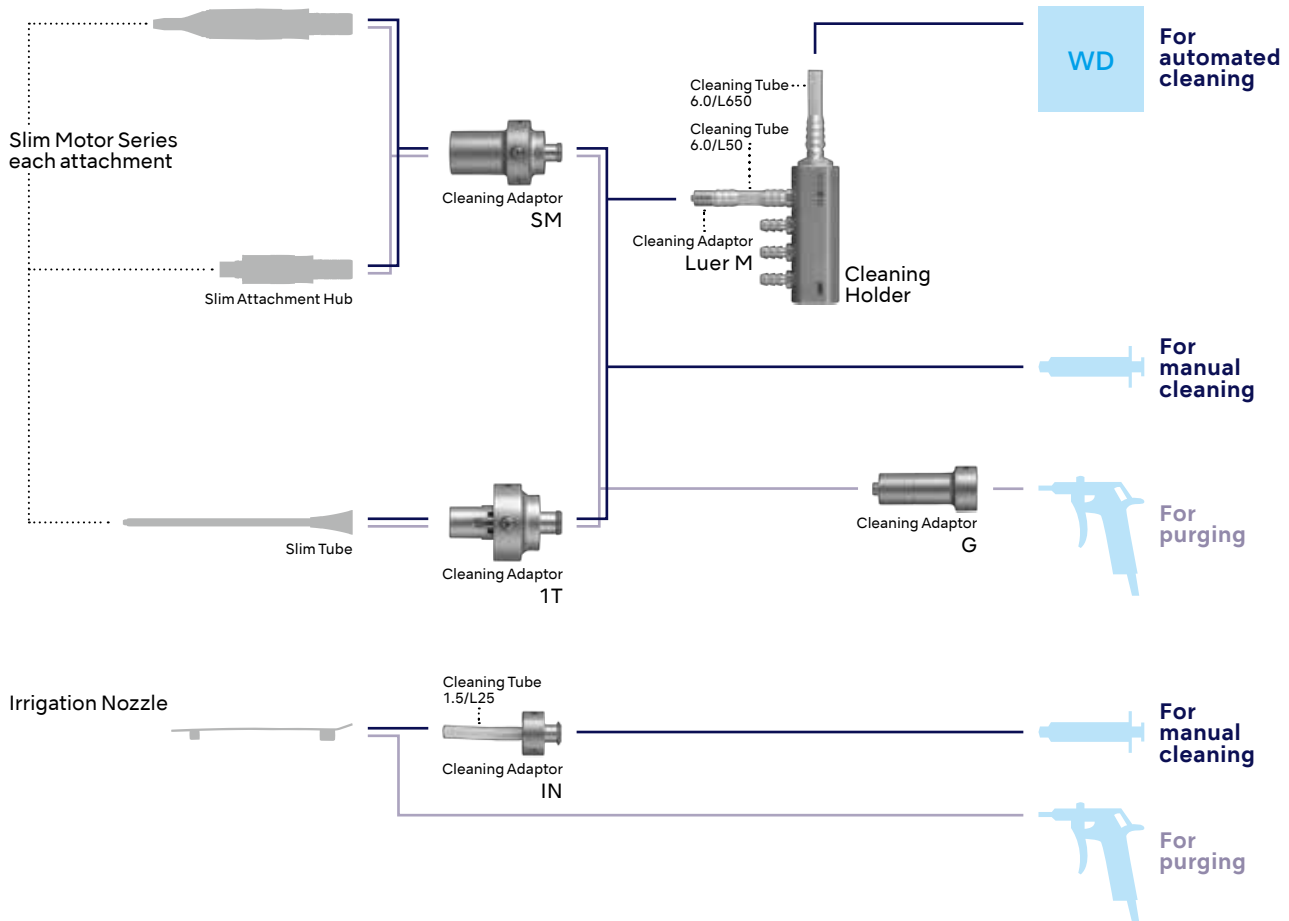
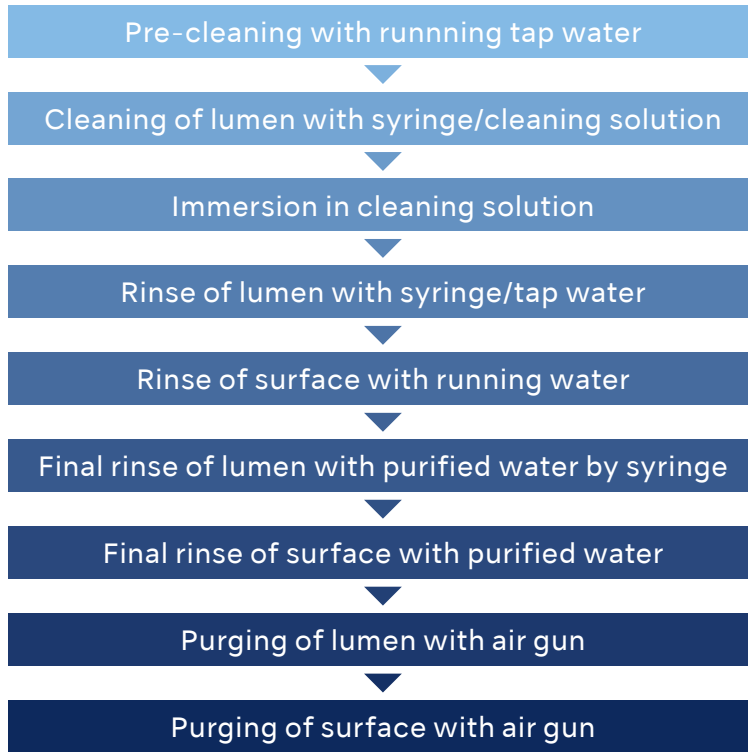

Washer disinfectant



# Cleaning process steps for manual cleaning



\*Please be sure to read the reprocessing manual.  
 \*These Cleaning Tools can not be used with the Bone Saw Attachment.  
 \*Cleaning Adaptor IN can not be used for automated cleaning.

Description		Order code	
Cleaning Holder		PD-CTH	Bundled Item: PD-CTTU-606501 PD-CTTU-600504
Cleaning Adaptor Luer M		PD-CTAD-LM	
Cleaning Adaptor SM		PD-CTAD-SM	
Cleaning Adaptor 1T		PD-CTAD-1T	
Cleaning Adaptor IN		PD-CTAD-IN	Bundled Item: PD-CTTU-150252
Cleaning Adaptor G		PD-CTAD-G	
Cleaning Tube 6.0/L650		PD-CTTU-606501	
Cleaning Tube 6.0/L50		PD-CTTU-600504	
Cleaning Tube 1.5/L25		PD-CTTU-150252	
EZ Spray Adaptor		PD-EZ-M	
Spray Adaptor for Slim		P200-EZ-SM	
Spray Adaptor for Bone Saw		P200-EZ-BM	
Spray Adaptor for WPD		P200-EZ-WPD	
PANA SPRAY Plus		Z182600	

Manufacturer

**NAKANISHI INC.** www.nsk-surgery.com  
700 Shimohinata, Kanuma, Tochigi 322-8666, Japan  
TEL: +81 289 64 3380 FAX: +81 289 64 3890

**NSK America Corp.**  
1800 Global Parkway, Hoffman Estates, IL 60192, USA  
TEL: +1 800 585 4675 FAX: +1 800 838 9328

Specifications are subject to change without notice. Cutting Accessories are sterilized and "Single Use" only.

PR-M0084ENV1 2023-06-02.NAM